

Système modulaire

Bras

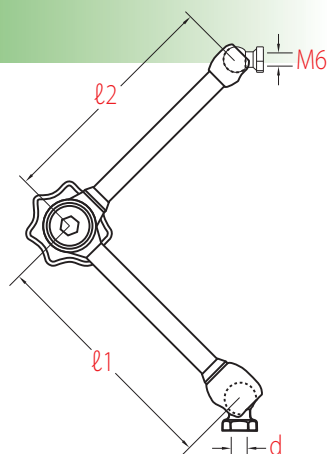

Montage femelle / femelle

l1	l2	d	Portée	Code	€
38	38	M6	2,0 Kg	NLC 9000	155,23
56	56	M6	3,0 Kg	NNF 9000	122,33
110	110	M6	4,0 Kg	NDG 9000	147,00
133	133	M8	5,0 Kg	NMG 9000	169,62
215	215	M8	6,0 Kg	NGR 9000	226,16

Accessoires

Vis de montage M6

	Filetage W 1/4"	NAD 6010	18,47 €
	Filetage W 3/8"	NAD 6030	18,47 €
	Filetage M6	NAD 6060	18,47 €
	Filetage M8	NAD 6080	18,47 €

Vis de montage M8

	Filetage W 3/8"	NAD 8030	18,47 €
	Filetage M8	NAD 8080	18,47 €

Vis de montage M10





	Filetage W 3/8"	NAD 1030	18,47 €
	Filetage M8	NAD 1080	18,47 €

Bases

12 modèles de bases magnétiques de 320 à 1300N - page 272

Attachements



Supports pour caméras, écrans, spots ...

	W 1/4 M6	NAD 6013	27,71 € Support métal Ø 32 - lg 38 mm Fixation pas Withwoth 1/4". Filetage M6 - W 1/4.
	W 1/4 M6	NAD 6015	29,30 € Support métal + semelle caoutchouc Ø 32 - lg 38 mm - Fixation pas Withwoth 1/4". Filetage M6 - W 1/4.
	W 1/4	NMA 0125	48,34 € Fixation pas Withwoth 1/4" - Ø 32. Avec support déporté 50 mm Filetage W 1/4.
	W 1/4 M6	NSJ 1001	210,74 € Support Orientable jusqu'à 6Kg Ø 32 - Fixation pas Withwoth 1/4". Filetage INT - W 1/4.
	W 1/4 M6	NAD 5000	63,22 € Support compact + serrage rapide Ø 30 - lg 40,5 mm - Fixation pas Withwoth 1/4". Filetage M6 - W 1/4.

Attache rapide

	W 1/4 M6	NAD 4000	85,94 € Changement rapide Ø 21 - lg 49 mm Fixation pas Withwoth 1/4". Filetage M6 - W 1/4.
--	-------------	-----------------	---

Pinces

		NCS 4550	87,01 € Nouvelle bride à mors doux pour maintien de pièces rondes ou plates. Ouverture jusqu'à 45 mm! Multi filetages M6, M8, 1/4" et 3/8".
		NNF 0125	34,38 € Bride Ouverture 25 mm. Pour maintien de pièces. Filetage M6.
		NDG 0125	43,50 € Bride Ouverture 50 mm. Pour maintien de pièces. Filetage M6.